

Watts and CCT Selectable UFO High Bay Pro

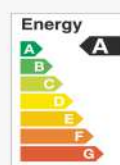

Features

1. Simple and stylish appearance.
2. Excellent heat dissipation.
3. DLC 5.1 Premium with high luminous efficacy and low UGR.
4. Branded driver and LED's.0-10V dimming
5. PnP sensor option.
6. Mounting options: hook/chain, pole pendent and surface mounting.
7. Round EM driver for fast installation.
8. Very complete accessories for option.
9. CCT(3500K-4000K-5000K).

Product Dimension

Unit: mm

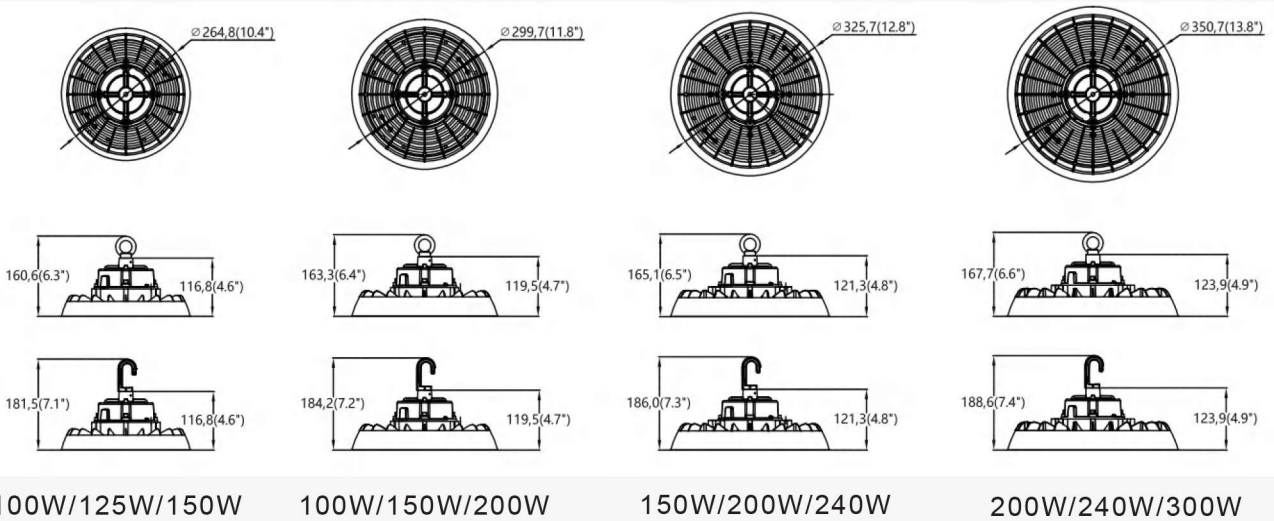

Lighting Parameters

Wattage	Working Voltage	CCT	Lamp Bead Model	LED Driver	Beam Angle	Lighting Efficiency	Color Rendering Index	Operating Temperature	Storage Temperature	Environment Location	Life span	Lamp shell
100W/125W/150W	AC 120~347V	3500K 4000K 5000K	2835	Branded driver	110°	135LM/W	Ra>80	-40°F~113°F	-40°F~158°F	Wet Location	≥50000H	Black & White
150W/200W/240W								-40°C~45°C	-40°C~70°C			
100W/150W/200W				Branded driver								
200W/240W/300W				Branded driver								

CCT and Watts selected Operation Manual

1.Remove the rubber pad from the driver

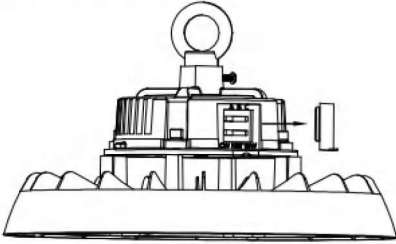

2.Use the slide switch to select wattage and CCT

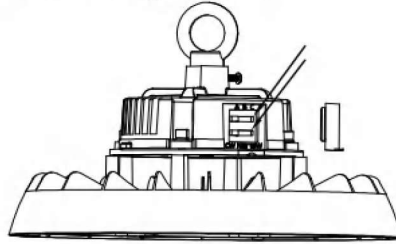

3.Attach the rubber pad to the driver

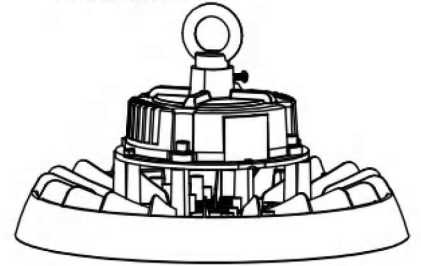

Installation Instruction

1. Rings type:

1.Tighten the ring clockwise

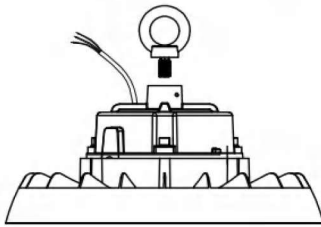

2.Tighten the screw

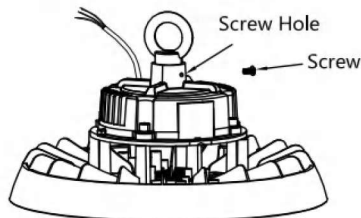

3.Hang the light

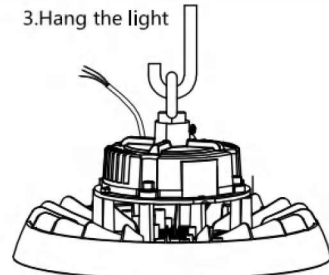

2. Hook type:

1.Tighten the hook clockwise

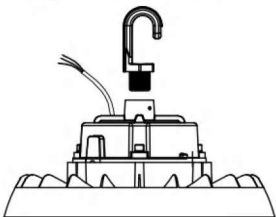

2.Tighten the screw

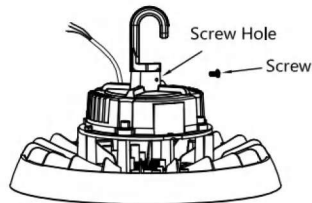

3.Hang the light

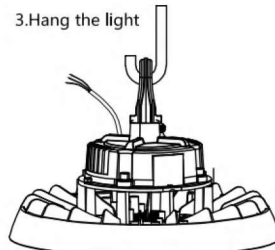

4.Tighten the screw

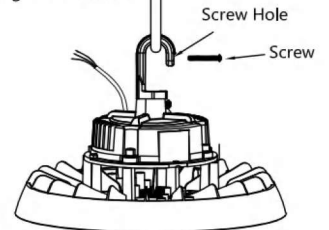

Packing information

Power	Outer box (L*W*H)	Oty/Ctn (pcs)	N.W./Ctn (kg/lbs)	G.W./Ctn (kg/lbs)	Remarks
100W/125W/150W	12.01"x12.01"x6.89" (305*305*175mm)	1	1.75/3.56	2.75/6.06	2M cable
100W/150W/200W	14.49"x14.49"x6.97" (368*368*177mm)	1	2.10/4.63	3.25/7.17	
150W/200W/240W	15.43"x15.43"x7.09" (392*392*180mm)	1	2.50/5.51	3.72/8.20	
200W/240W/300W	16.46"x16.46"x7.17" (418*418*182mm)	1	2.80/6.17	4.05/8.93	

Applications



Industrial application:
Warehouse, Factory etc.

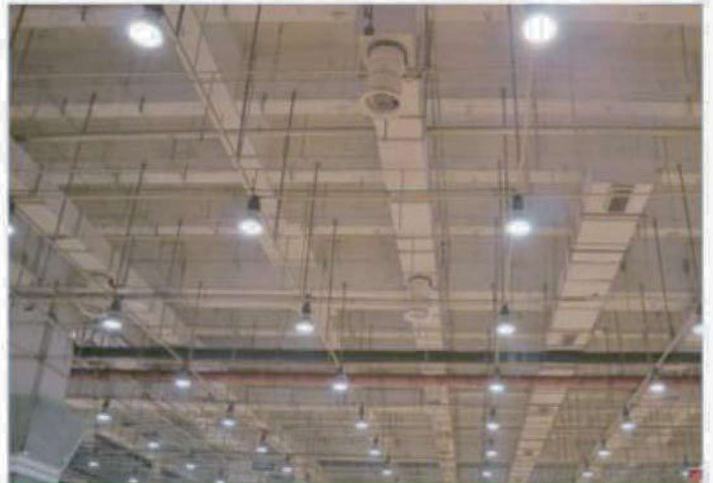

Commercial application:
Exhibition Room, Gas Station,
Supermarket etc.

Note

1. Any form of installation/uninstallation or maintenance and electrical work must only be performed by a qualified electrician.
2. All wiring should be done after cutting off the power.
3. The UFO high bay light must be grounded.
4. Always keep the lens/diffuser of UFO high bay light cleaned to maintain good light transmission.
5. Always keep the shell of UFO high bay cleaned to maintain good heat dissipation.
6. Cleaning must only be done with dry or wet cloth and the high bay should not be exposed to corrosive substance.
7. High voltage inside the fixture, please do not disassemble it, Serious electric shock may occur otherwise.